

ЕСК-150 Електрически дроп болт

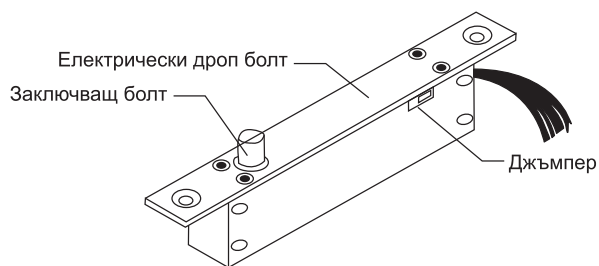

(8-цветни жила: червено, черно, синьо, бяло, зелено, сиво, оранжево)

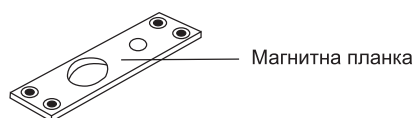

Фиг. 1

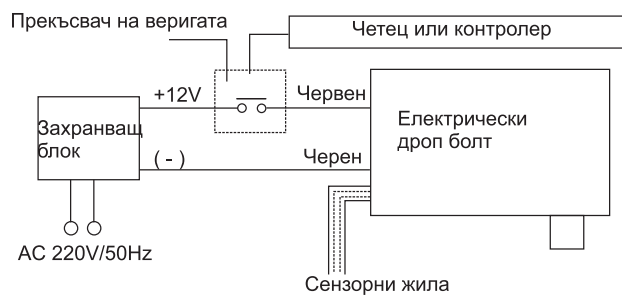

Фиг. 2

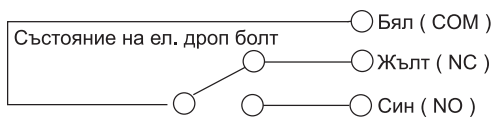

Фиг. 3А

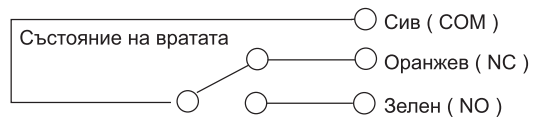

Фиг. 3Б

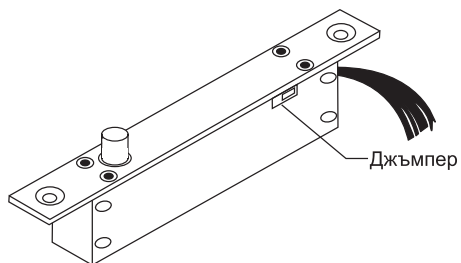

Фиг. 4

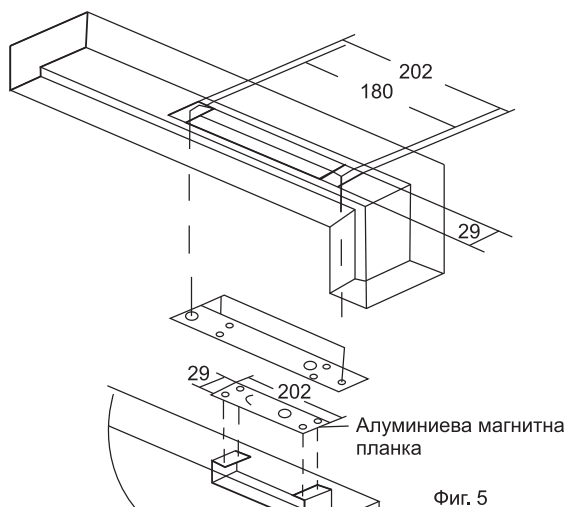

Фиг. 5